



MOSMIC[®] for TV-Tuner Prestage with 5 V Supply Voltage

Comments

MOSMIC - MOS Monolithic Integrated Circuit

Features

- Integrated gate protection diodes
- Low noise figure
- High gain
- Biasing network on chip
- Improved cross modulation at gain reduction
- High AGC-range
- SMD package
- Lead (Pb)-free component
- Component in accordance to RoHS 2002/95/EC and WEEE 2002/96/EC

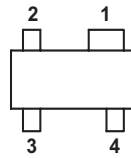

SOT-143

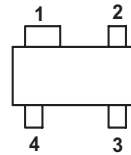
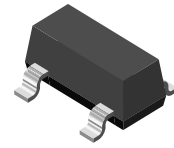

SOT-143R

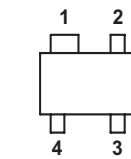
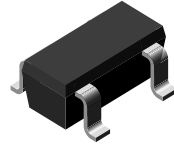

SOT-343R

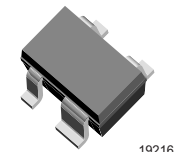

19216



Electrostatic sensitive device. Observe precautions for handling.

Applications

Low noise gain controlled input stages in UHF-and VHF- tuner with 5 V supply voltage.

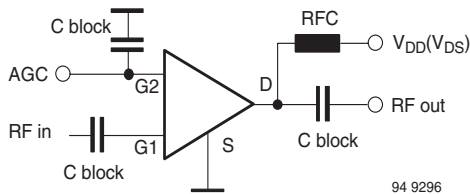

94 9296

Mechanical Data

Typ: S595T

Case: SOT-143 Plastic case

Weight: approx. 8.0 mg

Pinning: 1 = Source, 2 = Drain, 3 = Gate 2, 4 = Gate 1

Typ: S595TR

Case: SOT-143R Plastic case

Weight: approx. 8.0 mg

Pinning: 1 = Source, 2 = Drain, 3 = Gate 2, 4 = Gate 1

Typ: S595TRW

Case: SOT-343R Plastic case

Weight: approx. 6.0 mg

Pinning: 1 = Source, 2 = Drain, 3 = Gate 2, 4 = Gate 1

Parts Table

Part	Marking	Package
S595T	595	SOT-143
S595TR	59R	SOT-143R
S595TRW	W59	SOT-343R

Absolute Maximum Ratings

$T_{amb} = 25\text{ }^{\circ}\text{C}$, unless otherwise specified

Parameter	Test condition	Symbol	Value	Unit
Drain - source voltage		V_{DS}	8	V
Drain current		I_D	30	mA
Gate 1/Gate 2 - source peak current		$\pm I_{G1/G2SM}$	10	mA
Gate 1/Gate 2 - source voltage		$\pm V_{G1/G2SM}$	6	V
Total power dissipation	$T_{amb} \leq 60\text{ }^{\circ}\text{C}$	P_{tot}	200	mW
Channel temperature		T_{Ch}	150	$^{\circ}\text{C}$
Storage temperature range		T_{stg}	- 55 to + 150	$^{\circ}\text{C}$

Maximum Thermal Resistance

Parameter	Test condition	Symbol	Value	Unit
Channel ambient	1)	R_{thChA}	450	K/W

1) on glass fibre printed board (25 x 20 x 1.5) mm³ plated with 35 μm Cu

Electrical DC Characteristics

$T_{amb} = 25\text{ }^{\circ}\text{C}$, unless otherwise specified

Parameter	Test condition	Symbol	Min	Typ.	Max	Unit
Gate 1 - source breakdown voltage	$\pm I_{G1S} = 10\text{ mA}, V_{G2S} = V_{DS} = 0$	$\pm V_{(BR)G1SS}$	7		10	V
Gate 2 - source breakdown voltage	$\pm I_{G2S} = 10\text{ mA}, V_{G1S} = V_{DS} = 0$	$\pm V_{(BR)G2SS}$	7		10	V
Gate 1 - source leakage current	$+ V_{G1S} = 5\text{ V}, V_{G2S} = V_{DS} = 0$	$+ I_{G1SS}$			50	μA
	$- V_{G1S} = 5\text{ V}, V_{G2S} = V_{DS} = 0$	$- I_{G1SS}$			100	μA
Gate 2 - source leakage current	$\pm V_{G2S} = 5\text{ V}, V_{G1S} = V_{DS} = 0$	$\pm I_{G2SS}$			20	nA
Drain current	$V_{DS} = 5\text{ V}, V_{G1S} = 0, V_{G2S} = 4\text{ V}$	I_{DSS}	50		500	μA
Self-biased operating current	$V_{DS} = 5\text{ V}, V_{G1S} = \text{nc}, V_{G2S} = 4\text{ V}$	I_{DSP}	9	13	18	mA
Gate 2 - source cut-off voltage	$V_{DS} = 5\text{ V}, V_{G1S} = \text{nc}, I_D = 20\text{ }\mu\text{A}$	$V_{G2S(OFF)}$		1.0		V

Caution for Gate 1 switch-off mode:

No external DC-voltage on Gate 1 in active mode!

Switch-off at Gate 1 with $V_{G1S} < 0.7\text{ V}$ is feasible.

Using open collector switching transistor (inside of PLL), insert 10 k Ω collector resistor.

Electrical AC Characteristics

$T_{amb} = 25\text{ }^{\circ}\text{C}$, unless otherwise specified

$V_{DS} = 5\text{ V}, V_{G2S} = 4\text{ V}, I_D = I_{DSP}, f = 1\text{ MHz}$

Parameter	Test condition	Symbol	Min	Typ.	Max	Unit
Forward transadmittance		$ y_{21s} $	28	30	35	mS
Gate 1 input capacitance		C_{issg1}		2.3	2.7	pF
Feedback capacitance		C_{rss}		25		fF
Output capacitance		C_{oss}		1.1		pF
Power gain	$G_S = 2\text{ mS}, G_L = 0.5\text{ mS}, f = 200\text{ MHz}$	G_{ps}		28		dB
	$G_S = 3.3\text{ mS}, G_L = 1\text{ mS}, f = 800\text{ MHz}$	G_{ps}	17	20		dB



Parameter	Test condition	Symbol	Min	Typ.	Max	Unit
AGC range	$V_{DS} = 5\text{ V}$, $V_{G2S} = 1\text{ to }4\text{ V}$, $f = 800\text{ MHz}$	ΔG_{ps}	45			dB
Noise figure	$G_S = 2\text{ mS}$, $G_L = 0.5\text{ mS}$, $f = 200\text{ MHz}$	F		1		dB
	$G_S = 3.3\text{ mS}$, $G_L = 1\text{ mS}$, $f = 800\text{ MHz}$	F		1.3		dB

Common Emitter S-Parameters

f/MHz	S11		S21		S12		S22	
	LOG MAG	ANG	LOG MAG	ANG	LOG MAG	ANG	LOG MAG	ANG
		deg		deg		deg		deg
50	-0.01	-4.6	9.61	174.3	-63.13	88.0	-0.08	-2.1
100	-0.03	-9.2	9.56	167.9	-56.88	85.3	-0.10	-4.3
150	-0.11	-13.8	9.44	161.3	-53.46	82.8	-0.14	-6.4
200	-0.19	-18.1	9.30	155.1	-51.38	80.7	-0.16	-8.6
250	-0.28	-22.6	9.15	148.4	-49.76	78.3	-0.22	-11.0
300	-0.40	-26.8	9.00	142.7	-48.70	77.3	-0.26	-12.9
350	-0.51	-31.1	8.79	136.8	-47.92	76.4	-0.30	-15.1
400	-0.64	-35.2	8.62	130.7	-47.45	76.2	-0.38	-17.1
450	-0.78	-39.3	8.35	125.3	-47.23	76.7	-0.43	-18.8
500	-0.93	-43.2	8.17	119.7	-47.10	78.4	-0.49	-20.6
550	-1.07	-47.1	7.94	114.2	-47.22	82.3	-0.55	-22.6
600	-1.22	-50.8	7.71	108.7	-46.92	88.6	-0.60	-24.6
650	-1.36	-54.4	7.50	104.1	-46.68	92.6	-0.66	-26.1
700	-1.49	-58.2	7.26	99.1	-46.47	98.8	-0.70	-27.9
750	-1.65	-61.5	7.08	94.1	-46.45	107.2	-0.73	-29.8
800	-1.79	-65.2	6.86	89.2	-45.89	116.7	-0.78	-31.7
850	-1.94	-68.6	6.68	84.5	-44.77	125.9	-0.80	-33.4
900	-2.04	-72.0	6.44	79.3	-43.51	133.0	-0.85	-35.4
950	-2.17	-75.3	6.27	74.4	-41.91	137.1	-0.87	-37.2
1000	-2.29	-78.7	6.09	70.4	-40.66	138.5	-0.89	-39.1
1050	-2.42	-82.2	5.93	65.8	-39.81	140.6	-0.90	-41.1
1100	-2.58	-85.2	5.67	61.1	-38.89	143.6	-0.92	-42.6
1150	-2.70	-88.4	5.55	56.1	-37.91	145.8	-0.93	-44.6
1200	-2.78	-91.6	5.41	51.8	-36.76	148.3	-0.94	-46.7
1250	-2.89	-94.8	5.38	47.1	-35.65	149.7	-0.93	-49.1
1300	-3.00	-97.7	5.17	42.0	-34.63	150.1	-0.92	-51.0

Typical Characteristics (T_{amb} = 25 °C unless otherwise specified)

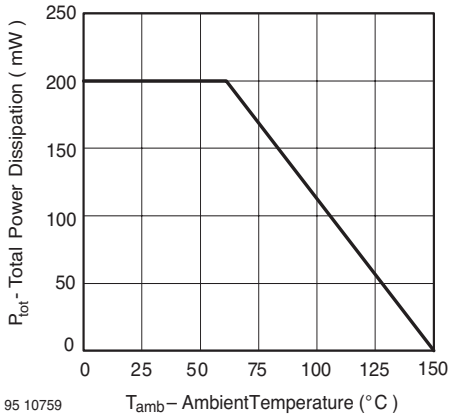

Figure 1. Total Power Dissipation vs. Ambient Temperature

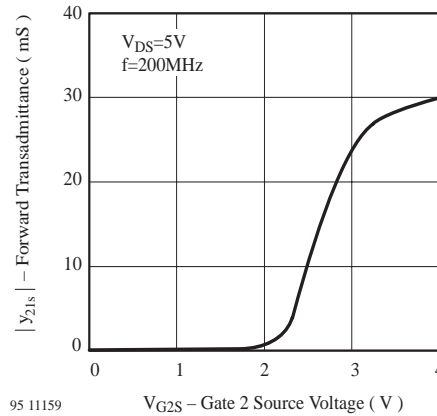

Figure 4. Forward Transadmittance vs. Gate 2 Source Voltage

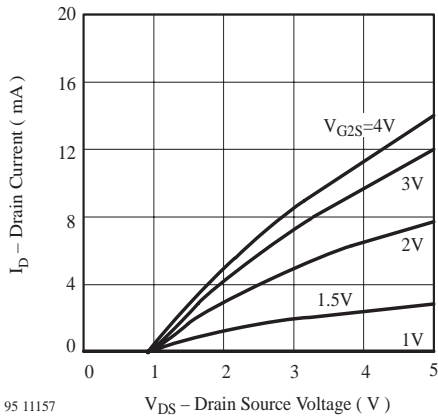

Figure 2. Drain Current vs. Drain Source Voltage

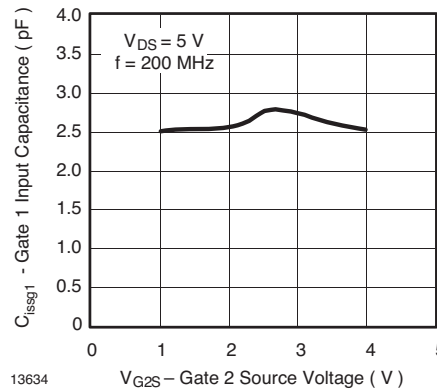

Figure 5. Gate 1 Input Capacitance vs. Gate 2 Source Voltage

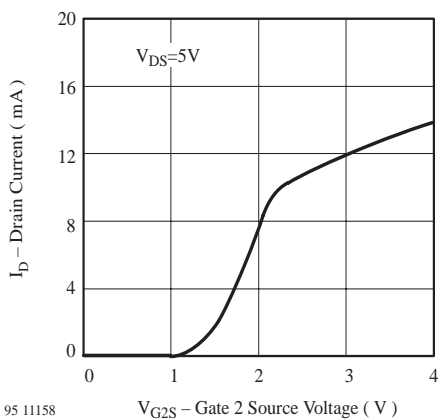

Figure 3. Drain Current vs. Gate 2 Source Voltage

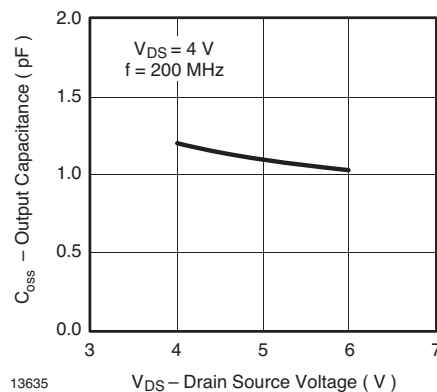

Figure 6. Output Capacitance vs. Drain Source Voltage

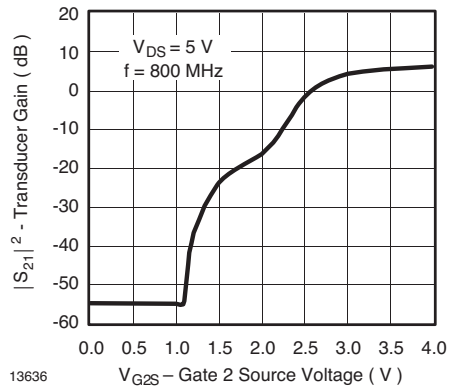

Figure 7. Transducer Gain vs. Gate 2 Source Voltage

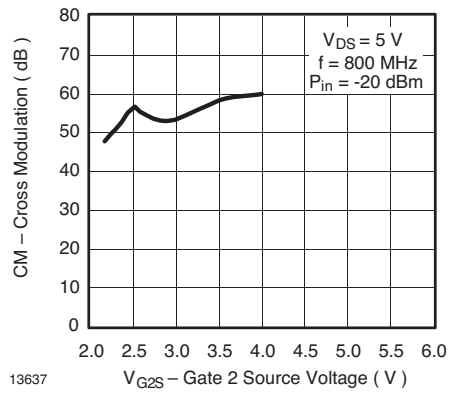

Figure 8. Cross Modulation vs. Gate 2 Source Voltage

S595T / S595TR / S595TRW



Vishay Semiconductors

$V_{DS} = 10\text{ V}$, $I_D = 10\text{ mA}$, $Z_0 = 50\ \Omega$

S_{11}

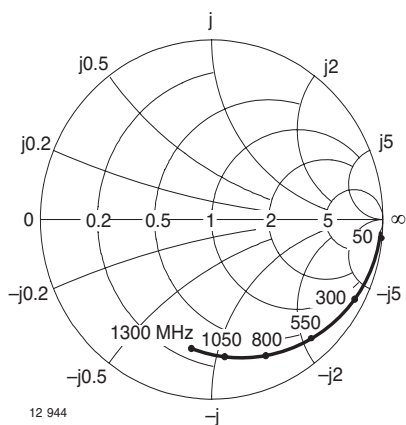

Figure 9. Input Reflection Coefficient

S_{12}

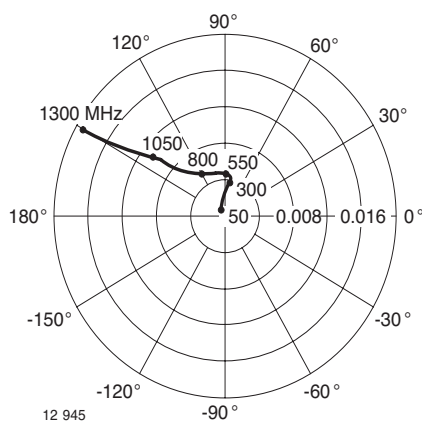

Figure 11. Reverse Transmission Coefficient

S_{21}

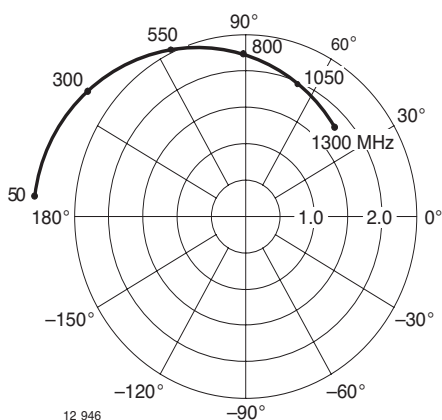

Figure 10. Forward Transmission Coefficient

S_{22}

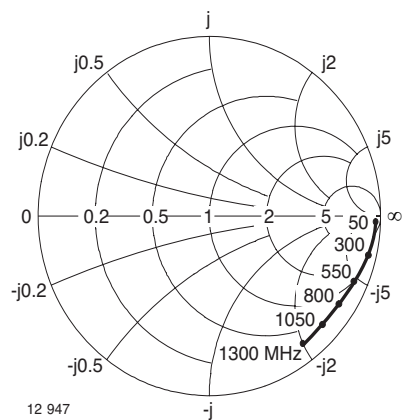
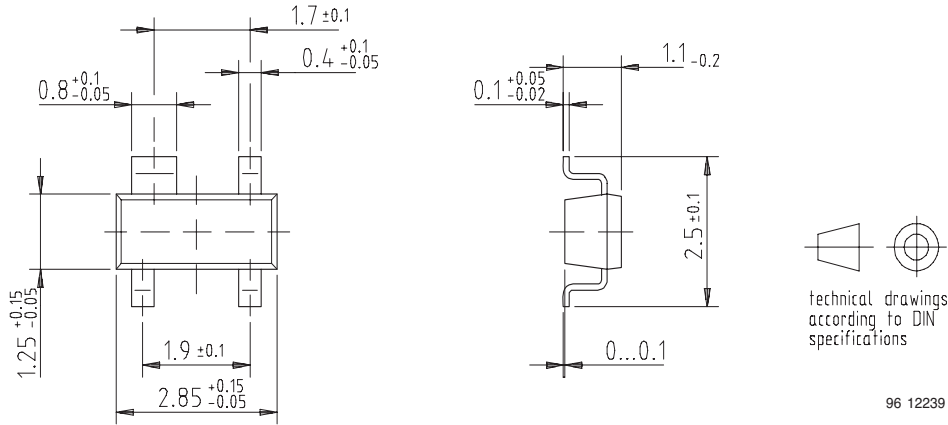
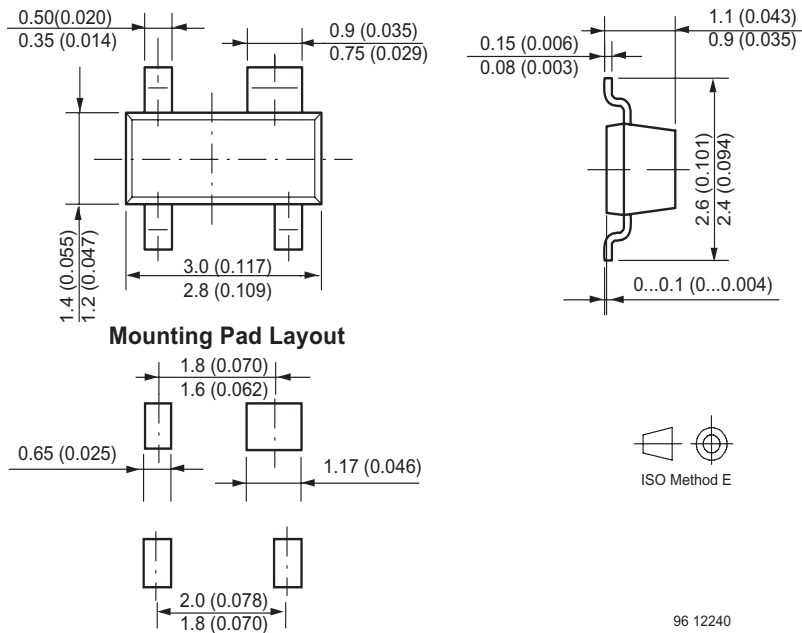

Figure 12. Output Reflection Coefficient

Package Dimensions in mm



Package Dimensions in mm



S595T / S595TR / S595TRW

Vishay Semiconductors



Package Dimensions in mm

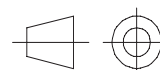
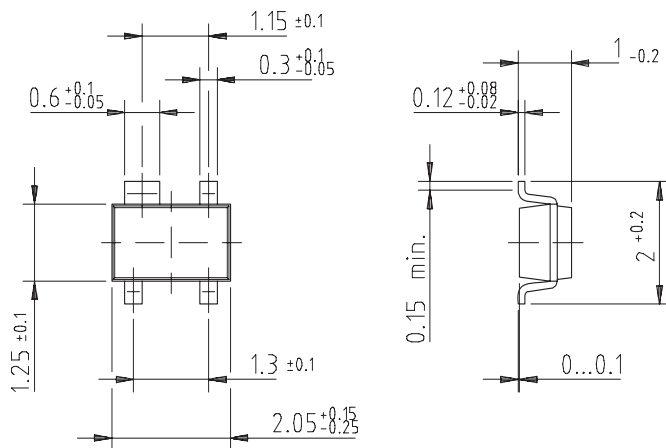

technical drawings
according to DIN
specifications

96 12238



Ozone Depleting Substances Policy Statement

It is the policy of Vishay Semiconductor GmbH to

1. Meet all present and future national and international statutory requirements.
2. Regularly and continuously improve the performance of our products, processes, distribution and operating systems with respect to their impact on the health and safety of our employees and the public, as well as their impact on the environment.

It is particular concern to control or eliminate releases of those substances into the atmosphere which are known as ozone depleting substances (ODSs).

The Montreal Protocol (1987) and its London Amendments (1990) intend to severely restrict the use of ODSs and forbid their use within the next ten years. Various national and international initiatives are pressing for an earlier ban on these substances.

Vishay Semiconductor GmbH has been able to use its policy of continuous improvements to eliminate the use of ODSs listed in the following documents.

1. Annex A, B and list of transitional substances of the Montreal Protocol and the London Amendments respectively
2. Class I and II ozone depleting substances in the Clean Air Act Amendments of 1990 by the Environmental Protection Agency (EPA) in the USA
3. Council Decision 88/540/EEC and 91/690/EEC Annex A, B and C (transitional substances) respectively.

Vishay Semiconductor GmbH can certify that our semiconductors are not manufactured with ozone depleting substances and do not contain such substances.

We reserve the right to make changes to improve technical design and may do so without further notice.

Parameters can vary in different applications. All operating parameters must be validated for each customer application by the customer. Should the buyer use Vishay Semiconductors products for any unintended or unauthorized application, the buyer shall indemnify Vishay Semiconductors against all claims, costs, damages, and expenses, arising out of, directly or indirectly, any claim of personal damage, injury or death associated with such unintended or unauthorized use.

Vishay Semiconductor GmbH, P.O.B. 3535, D-74025 Heilbronn, Germany



Notice

Specifications of the products displayed herein are subject to change without notice. Vishay Intertechnology, Inc., or anyone on its behalf, assumes no responsibility or liability for any errors or inaccuracies.

Information contained herein is intended to provide a product description only. No license, express or implied, by estoppel or otherwise, to any intellectual property rights is granted by this document. Except as provided in Vishay's terms and conditions of sale for such products, Vishay assumes no liability whatsoever, and disclaims any express or implied warranty, relating to sale and/or use of Vishay products including liability or warranties relating to fitness for a particular purpose, merchantability, or infringement of any patent, copyright, or other intellectual property right.

The products shown herein are not designed for use in medical, life-saving, or life-sustaining applications. Customers using or selling these products for use in such applications do so at their own risk and agree to fully indemnify Vishay for any damages resulting from such improper use or sale.